

Installation guide

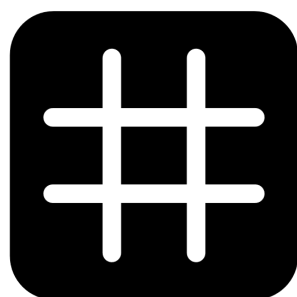

dingz

Manual for electricians

V1.01 - May 2022

Content

Introduction	3
General	4
Technical data	5
Functions & possibilities	6
Devices and dingz colours	8
Mounting of the dingz base	9
Front dingz montage	12
Connection of dimmable lamps	13
Diagram 0	14
Diagram 1	15
Diagram 3	16
Diagram 6	18
Current pulse circuit (Stairs)	20
Current pulse circuit with external relay (Stairs)	23
Motion detector	24
Connection of electric blinds	26
Combining lamps and blinds	29
Connection of an electric heating valve	30

Introduction

This manual is intended for electrical installers and planners. It describes the assembly, installation and configuration of the functions supported by the dingz. You will also find many tips on how to use the dingz in an even more flexible and extensive way or how to carry out the installation efficiently.

The following subjects are described:

- Possible applications of the dingz
- Lamp installation with 0/3/6 scheme and current pulse switching / corridor / stairs
- Connection of electric blind motors
- Connection of electric heating valves
- Connection of external switch or motion detectors
- Configuration of the dingz switch via the web interface

TIP: A detailed description of all parameters can be found in the document "Webinterface instructions" in the "Help" tab on dingz.ch

General

The installation must be carried out by a competent electrician. Above all, the electrician must ensure a functional, compliant and safe installation. Make sure that the DIP switches on the base are set correctly when the blind motors are connected directly to the base, otherwise you risk damaging the dingz and the motors.

Some wiring involves using connector 1 of the dingz as an input. This must be configured accordingly in the web interface.

TIP: We recommend assigning part and device names in the dingz web interface. These will be displayed when ordering each dingz later via our application or when integrating with other manufacturers such as myStrom and will simplify the use considerably.

Technical data

dingz always consists of a "front" and a base (the frame is not included)

4 dimmable outputs with phase section, suitable for capacitive and resistive loads

Nominal voltage 230 V ~ ± 10 %

Frequency 50 Hz

Power consumption dingz front & base 1W

Incandescent lamp 0 - 100 W per output

Halogen lamp 0 - 100 W per output

Dimmable LED lamp 0 - 100 W per output

Electronic current transformer 0 - 100 W per output. Not suitable for conventional transformer current

Non-dimmable loads 0 - 230 W per output

4 freely configurable buttons

Motors 30 W - 300 W per motor

Motion detector with a range of 5 meters (H 100° / V 82°)

Protection against overheating: The load is deactivated and the LED flashes red (10s)

Overload protection: The load is deactivated and the LED flashes red (10s)

Operating temperature: -10 °C à +40 °C, storage temperature +5 °C à +40 °C

Pipe dimension for wire or strand (with or without end cap) from 0.2 mm² to 2.5 mm².

Wall overhang 11 mm, Installation depth 31.5 mm

Colors: white, light grey, anthracite, mocca, black

Protection rating: IP20

Dimensions: 60 x 60 mm (88 x 88 mm with Feller frame), 28g front, 80g base

Functions & possibilities

Here is an overview of the devices that can be replaced and automated by a dingz. Since dingz has no electromechanical elements and controls its four universal outputs via patented electronics, all switching operations are silent (no relay clicks).



Buttons. A dingz has four buttons, which can be freely configured: These control: lights, blinds, fan, external relays/contactors, heating valves, or even other smart home devices via WiFi, such as dingz, myStrom, Philips HUE, Sonos,...

Blinds. One or two blind motors (with limit switches) can be connected directly to dingz. After the automatic calibration of the blinds, dingz can move the blind positions and slat angles precisely.

Dimmers. Four groups of lights can be connected directly to the four outputs and switched / dimmed individually or together. For each group, individual light intensity curves can be stored, allowing synchronous dimming of different lamps. Dingz uses phase control and is suitable for resistive and capacitive loads up to 100W per channel (400W total). If the loads are exclusively switched and not dimmed, the individual outputs can be loaded up to 230W. Dingz always switches at zero crossing and thus avoids high inrush currents and electromagnetic interference (crackling of audio devices). The dimmer also works without minimum load and at 100%, there is no reduction in maximum brightness as with other dimmers on the market.

Motion detector. dingz is available in two versions: with or without motion detector. dingz plus has a motion detector including a brightness sensor and can switch the luminaires on or off gently depending on the ambient lighting. There are three states (day / dusk / night) and different dimming values can be configured for each state. As dingz also has push buttons, it is possible to operate manually at any time and adjust the brightness.



Heating. An electric heating valve (230V) for floor heating can be connected directly to one of the four outputs and is controlled by the internal temperature sensor. The setpoint temperature can be adjusted directly with the buttons on the dingz, for this purpose one button is defined as a thermostat button. Even more convenient and if desired for all rooms at the same time, the setting can also be done with the dingz app.



External actuators. Output 1 can also be used as an input and allows the connection of external buttons, motion detectors or other dingz. This makes it possible to operate push buttons, motion detectors and dingz in a network (staircase) even without WiFi and to easily integrate existing or special devices (e.g. IP67).

For example, it is possible to control a blind with a single IP67 outdoor push button from any manufacturer.

Combinations with dingz. dingz is compatible with frames and other products from these manufacturers and series:

- **Feller** EDIZIOdue
- **Hager** kallysto.line / kallysto.trend / kallysto.pro
- **ABB** Sidus

Devices and dingz colours

Design. A dingz always consists of a front and a base.



Color variants. The fronts are available in five color variants, with or without motion detector (frame and mounting plate not included).



Mounting of the dingz base

dingz can be surface or flush mounted and fits into most of the mounting boxes commonly used in Switzerland. With a mounting depth of only 31.5 mm, there is sufficient space for cables and terminals behind the device.

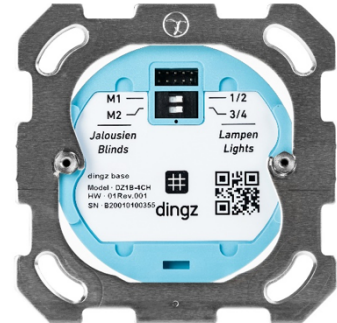

ONLY ONE OUTER CONDUCTOR (PHASE) MAY BE CONNECTED PER DINGZ. MIXING L1, L2 OR L3 ON THE SAME DINGZ IS NOT ALLOWED. ALL LOADS OR PUSH BUTTONS CONNECTED TO A DINGZ MUST BELONG TO THE SAME FUSE CIRCUIT. THE NEUTRAL CONDUCTOR MUST BE CONNECTED TO THE DINGZ BASE. OPERATION WITHOUT A NEUTRAL CONDUCTOR IS NOT POSSIBLE.

DIP switch setting. A dingz is installed and connected like a conventional dimmer or blind switch. Up to four lamps or two blind motors can be controlled directly by a dingz base. To do this, the corresponding devices are connected to the outputs of the dingz base and the corresponding operating mode is set using the base's DIP switches.

The following combinations are possible:

- **4 lamps (1, 2, 3, 4)**
Dip switch 1 = right / Dip switch 2 = right
- **1 motor / blind (1+2) und 2 Lamps (3, 4)**
Dip switch 1 = left / Dip switch 2 = right
- **2 lamps (1, 2) und 1 motor / blind (3+4)**
Dip switch 1 = right / Dip switch 2 = left
- **2 motors / blinds (1+2, 3+4)**
Dip switch 1 = left / Dip switch 2 = left

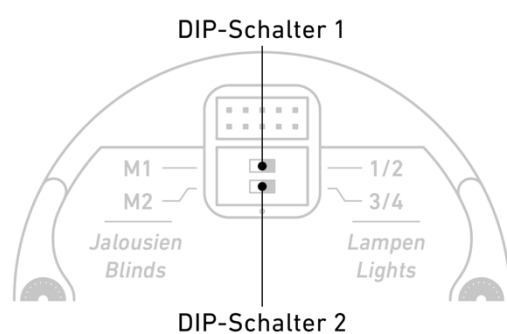

Installation. Installation is in conventional mounting boxes with a minimum depth of 40 mm. Metal frames from Feller (not included) or from other compatible manufacturers are used for mounting. Dingz can be freely combined with sockets or other devices of the EDIZIOdue series from Feller or other compatible manufacturers.

The base is attached to the metal frame with the two hexagonal screws, which are already pre-mounted on the base. You just have to loosen them slightly to be able to fix the base to the frame.

Please note that metal frames have countersunk holes on one side only. If the metal frame is mounted the wrong way around, the faceplate may not lay flat on the frame.

Rigid or flexible conductors with a cross-section of 0.2 mm² to 2.5 mm² can be connected directly with or without cable ferrules.

Fixing the cables. Rigid cables or cable ends can be inserted directly into the round holes provided without tools.

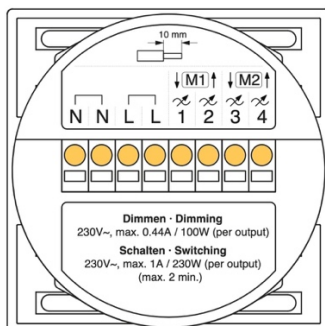

Remove the cables. To remove cables or to insert stranded cables without cable end, a flat screwdriver (phase tester) is inserted into the corresponding rectangular hole.

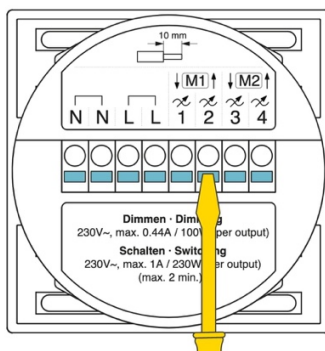

Mounted in housing. Once the base is attached to the metal frame and fully wired, the assembly is screwed to the in-wall box (surface or recessed) as usual.

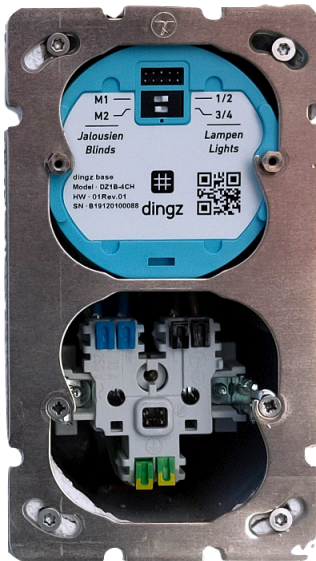

Front dingz montage

Plug in. After placing the appropriate plastic frame (not included), the front panel is attached to the base.

Remove the central cover. Use a size 1 flathead screwdriver to remove the center front cover.

TIP: The front panel can also be pushed onto the base without removing the center cover by pressing lightly on the middle of the top and bottom buttons (see red arrows below) at the same time, causing the center cover to pop out. The center cover can now be removed without tools.

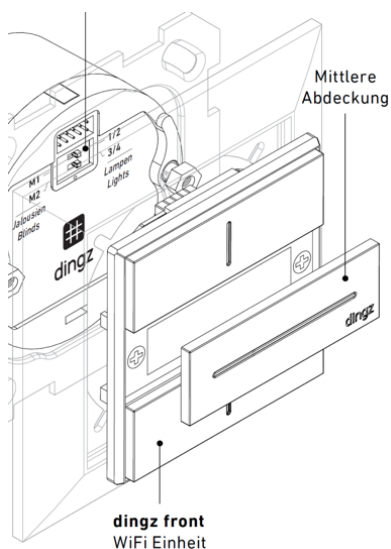

The front is now fixed by slightly tightening the two Phillips screws (Pozidrive taille 1).

THE SCREWS SHOULD ONLY BE SLIGHTLY TIGHTENED, OTHERWISE THE OPERATION OF THE PUSH BUTTONS WILL BE AFFECTED.

Perform a function test. Before replacing the center front cover and completing the electrical installation, all buttons should be operated once and checked for proper mechanical operation. If necessary, slightly loosen the two Phillips screws.

Connection of dimmable lamps

Up to four lamps can be connected directly to the dingz base and dimmed as needed. Dingz supports most common installation types. When delivered, buttons 1 to 4 are directly assigned to the corresponding outputs, which makes it easy to check the installation without additional configuration of the web interface. If loads are connected to certain outputs, which do not support dimming by means of a phase section, the dimmer function for these outputs must be disabled in the web interface. To do this, the "non-variable" type must be selected in the drive menu.

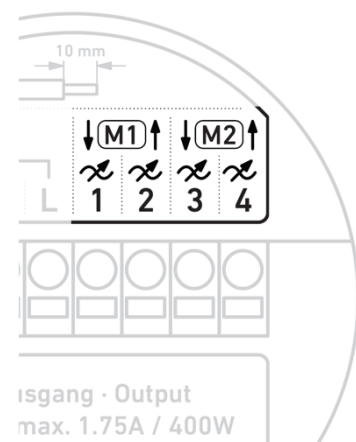

TIP: You can find a detailed description of all settings in the dingz Webinterface document in the "Support" tab of our website. dingz.ch

When leaving the factory, the buttons 1 to 4 directly control the variable outputs 1 to 4, allowing immediate control of the installation without additional configuration.

The following pages show the different configurations and connection options of dingz.

Pour utiliser les sorties comme variateurs, les interrupteurs DIP correspondants de la base doivent être réglés sur la position lampe.

TO USE THE OUTPUTS AS DIMMERS, THE CORRESPONDING DIP SWITCHES ON THE BASE MUST BE SET TO THE LAMP POSITION.

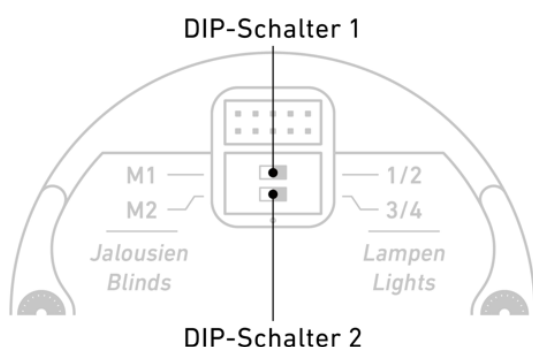

Diagram 0

This circuit is used to switch or dim a luminaire or group simultaneously from one position.

Application. In rooms with only one accessible switch point, ex. toilet, storage room, bedroom, etc.

This application allows the simultaneous switching of a lamp or a group from one point and is activated by a short press on the corresponding button. By pressing a button for a longer period, the corresponding output can be dimmed, provided that this function has not been deactivated beforehand.

Configuration. No configuration is required for this circuit (corresponds to factory settings).

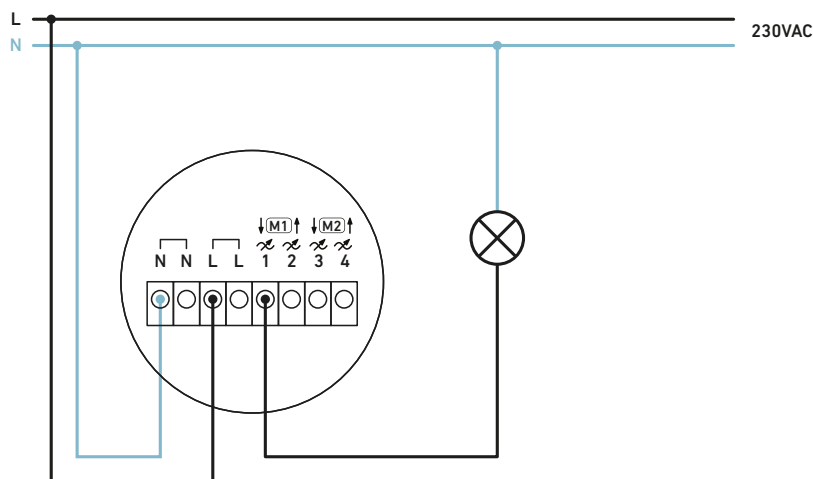

Diagram 1

This circuit is used to switch or dim a luminaire or group simultaneously from one position.

Application. In rooms with only one accessible switch point, ex. toilet, storage room, bedroom, etc.

In this application, simultaneous switching of a lamp or group from one place is possible and is actuated with a short press on the corresponding key. By pressing a button for a longer time, the corresponding output can be dimmed, provided that this function has not been deactivated beforehand.

Configuration. No configuration is required for this circuit (corresponds to factory settings).

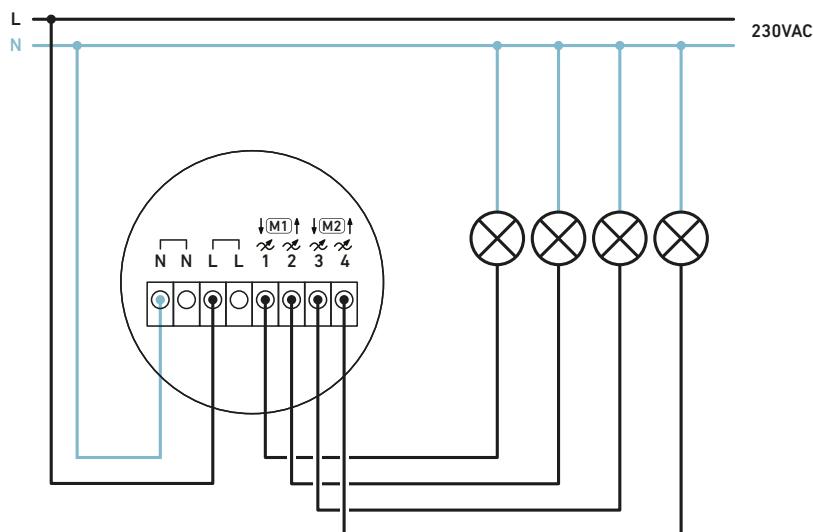

Diagram 3

This circuit is used to switch or dim a lamp or group from two positions.

Application. In rooms with two access points (two switching points), for example in corridors or large rooms.

With this application, the individual switching or dimming of a lamp or group is possible from two locations and is operated by a short press on the corresponding dingz or external button. The corresponding output can be dimmed by a longer press on a dingz or external button, provided that this function has not been deactivated beforehand.

DIFFERENT PHASE CONDUCTORS (L1, L2 OR L3) OR NEUTRAL CONDUCTORS OF DIFFERENT FUSE GROUPS MAY NOT BE MIXED ON THE SAME DINGZ. IT IS FORBIDDEN TO CONNECT LOADS SUPPLIED BY A DIFFERENT EARTH LEAKAGE CIRCUIT BREAKER THAN THE DINGZ.

Configuration. For this circuit, an adjustment of the configuration in the web interface of the dingz switch is necessary, so that port 1 can be used as input and control output 2:

- **Input -> activate = on** (port 1 is used as input)
- **Input -> output = 2** (output 2 is controlled by the input)

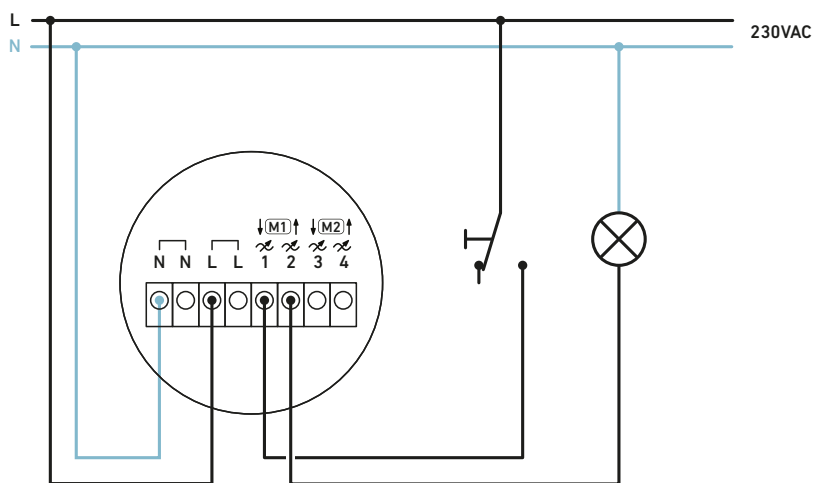

TIP: When upgrading an existing switch with dingz, the switch to be used as a pushbutton must be reconfigured or replaced. One of the two contacts is then connected to terminal 1 (input) of the dingz to be controlled. The second contact can be permanently connected to L in order to permanently power the remote dingz.

Diagram 6

This circuit is used to switch or dim a luminaire or group from two or more positions.

Application: In rooms with several access points, for example in corridors or large rooms...

With this application, the individual switching or dimming of a lamp or group is possible from several locations and is operated by a short press on the corresponding dingz or external button. The corresponding output can be dimmed by a longer press on a dingz or external button, provided that this function has not been deactivated beforehand.

DIFFERENT PHASE CONDUCTORS (L1, L2 OR L3) OR NEUTRAL CONDUCTORS OF DIFFERENT FUSE GROUPS MAY NOT BE MIXED ON THE SAME DINGZ. IT IS FORBIDDEN TO CONNECT LOADS SUPPLIED BY A DIFFERENT EARTH LEAKAGE CIRCUIT BREAKER THAN THE DINGZ.

Configuration. For this circuit, an adjustment of the configuration in the web interface of the dingz switch is necessary, so that port 1 can be used as input and control output 2:

- **Input -> activate = on** (connection 1 is used as input)
- **Input -> output = 2** (output 2 is controlled by the input)
- **Input -> reverse = on** (the input is controlled by the interruption of L)

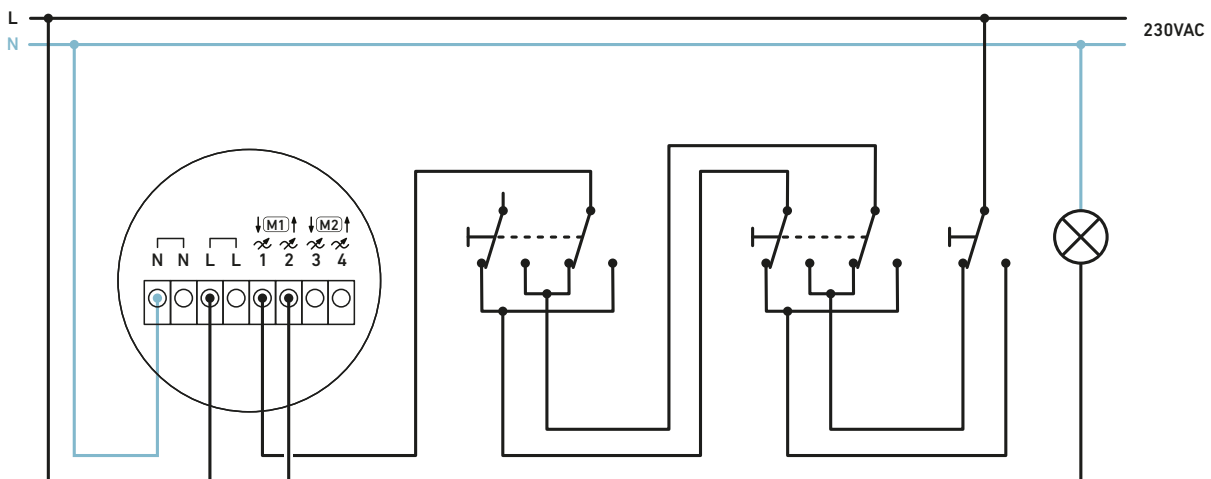
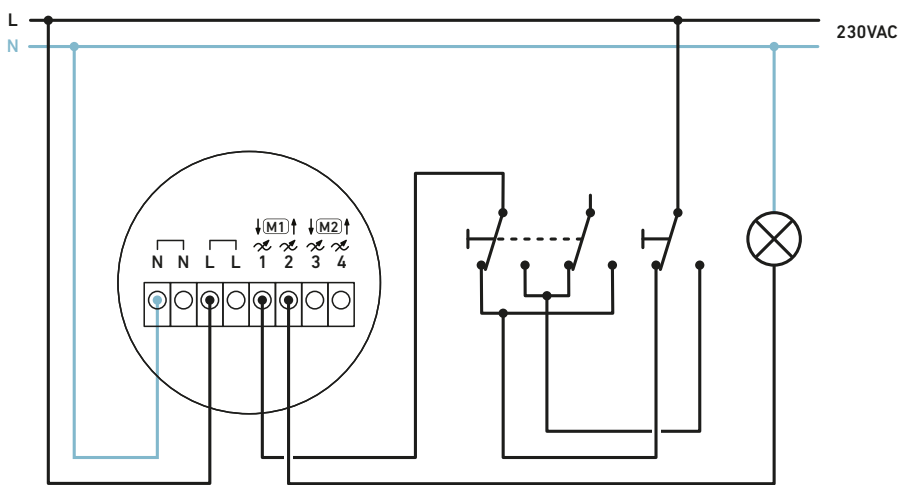

Current pulse circuit (Stairs)

This circuit is used to switch or dim a luminaire or group from any number of positions.

Application: In rooms with many access points (switching points), ex. in stairwell, corridors or large room.

With this application, the individual switching or dimming of a lamp or group is possible from any position and is activated by a short press on the corresponding dingz or external button. The corresponding output can be dimmed by a long press on a dingz or external button, provided that this function has not been deactivated beforehand.

DIFFERENT PHASE CONDUCTORS (L1, L2 OR L3) OR NEUTRAL CONDUCTORS OF DIFFERENT FUSE GROUPS MAY NOT BE MIXED ON THE SAME DINGZ. IT IS FORBIDDEN TO CONNECT LOADS SUPPLIED BY A DIFFERENT EARTH LEAKAGE CIRCUIT BREAKER THAN THE DINGZ.

There are different types of wiring to control a dingz with external switches or to operate several dingz in a network.

Configuration for the push buttons in series: For this circuit, an adjustment of the configuration in the web interface of the dingz switch is necessary, so that port 1 can be used as input and control output 2:

- **Input -> activate = on** (connection 1 is used as input)
- **Input -> output = 2** (output 2 is controlled by the input)
- **Input -> reverse = on** (the input is controlled by the interruption of L)

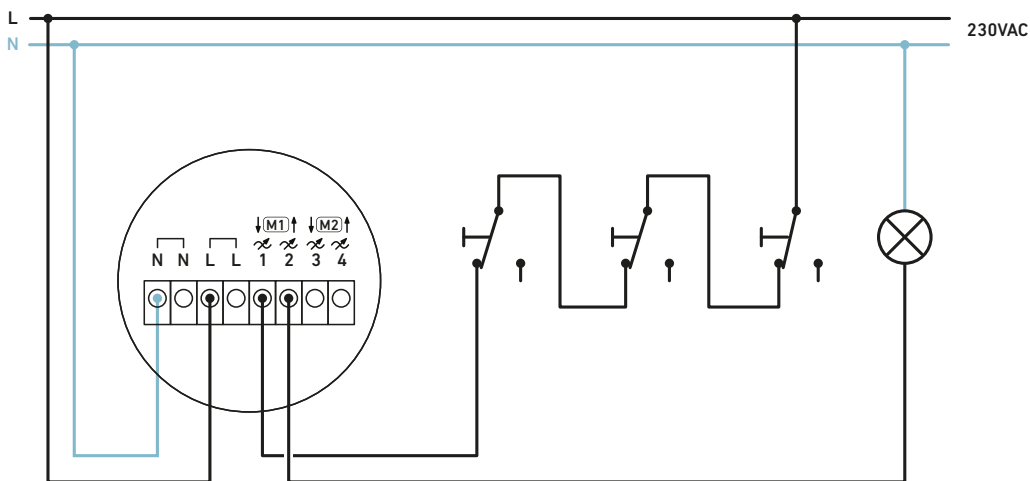

Configuration for push buttons in parallel connection: For this circuit, an adjustment of the configuration in the web interface of the dingz switch is necessary, so that port 1 can be used as input and control output 2:

- **Input -> activate = on** (connection 1 is used as input)
- **Input -> output = 2** (output 2 is controlled by the input)

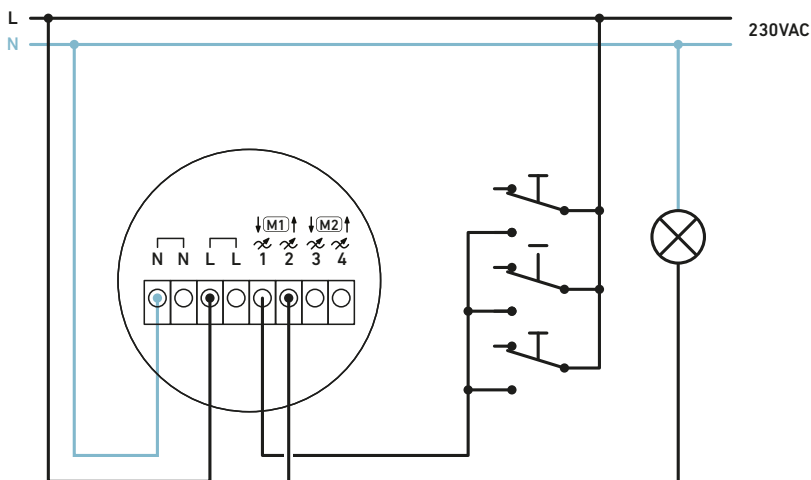

Instead of external buttons, it is also possible to use additional dingz, whose connections have been configured as pulse outputs.

Configuration for additional dingz with pulse output: For additional dingz, an adjustment of the configuration in the web interface is necessary, so that one or more outputs can be used as push buttons:

Dimmer -> type = pulse (for each dimmer that controls another dingz)

Current pulse circuit with external relay (Stairs)

Push button (pulse contact): If an external pulse or time relay is already installed or is required to switch large loads, the outputs of the dingz can be configured as push buttons (pulse).

TIP: External relays should not be used for new installations because they do not allow for attenuation, are not quiet, and intelligent systems cannot query the switching status.

Configuration for the use of an external relay: For use with an external relay, an adjustment of the configuration in the dingz web interface is necessary, so that one or more dingz outputs can be used as push buttons:

Dimmer -> type = pulse (for each dimmer controlling a relay).

Motion detector

The motion detector of a dingz plus can control up to four different lights or groups. An individual dimming curve and value can be defined for each of the four outputs.

Factory setting. The outputs that are controlled by the motion detector are configured in the web interface. By default, the motion detector is connected to output 2.

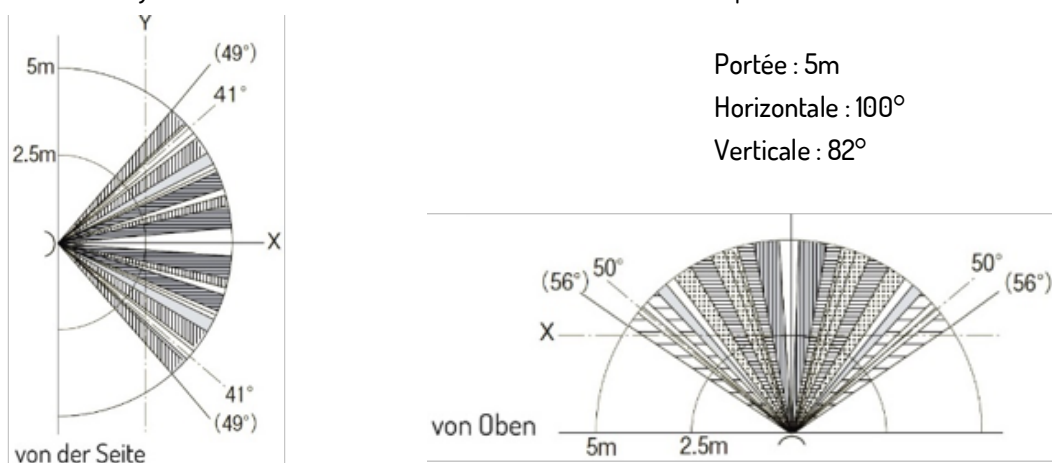

Operating multiple motion detectors together. If several motion detectors (dingz or other manufacturers) are to be operated in a network, these (slaves) can all be connected in parallel to the input (connection 1) of the dingz (master) connected to the luminaires. These additional motion detectors (set the shortest possible switch-on time for them) then all together control the master dingz timer.

Configuration dingz with lights (Master). This circuit requires a configuration adjustment in the dingz switch web interface so that port 1 can be used as an input and control the motion detector timer:

- **Input -> activate = on** (connection 1 is used as input)
- **Input -> output = PIR** (The input controls the timer of the internal motion detector).

Configuration of the dingz as an external motion detector (slave). Output 2 is controlled by the default motion detector and can be connected to the input of the master dingz. If another output is used, it must be selected in the web interface (motion detector):

- **Dimmer -> type = non dimmable** (controls the input of another dingz)
- **Motion detector -> output = 2** (if it is connected to the master input)
- **Motion detector -> insertion time = 0 / fade time = 0**
- **Motion detector -> light off = 1s**

Connection of electric blinds

The blinds can be operated with one button or two buttons, depending on the customer's preferences or requirements. In the delivery state, the operation with two buttons per blind is preconfigured. If an output is configured for the blinds by means of a DIP switch, the connected blind motors can be raised and lowered without further adjustment. If desired, each blind can be individually reconfigured for one-button operation. It is also possible to configure the dingz so that a single button controls two blind motors simultaneously. After installation, the blind calibration must be started once in the web interface.

Connecting to the dingz. After the electrical installation of the blind motor and the correct setting of the limit switches, the two outer conductors of the motor are connected to outputs 1&2 or 3&4. The neutral conductor (N) and the protective earth (PE) are connected directly to the corresponding supply lines. One or two blinds can be operated separately on a single dingz base.

TIP: If the two outer conductors of the motor were accidentally connected in the wrong direction during the electrical installation, they can simply be reversed via the web interface. No need to disassemble a second time :-)

CONNECTING MORE THAN ONE MOTOR TO THE SAME OUTPUT IS NOT ALLOWED AND WILL CAUSE MOST AWNING MOTORS TO MALFUNCTION OR BE DESTROYED. BEFORE POWERING UP THE POWER SUPPLY, IT IS IMPERATIVE TO CONFIGURE THE OUTPUTS WIRED TO THE MOTORS USING THE BLIND DIP SWITCHES. INCORRECT CONFIGURATION CAN RESULT IN THE DESTRUCTION OF THE MOTORS AND DINGZ!

The following combinations with blind motors are possible:

One blind

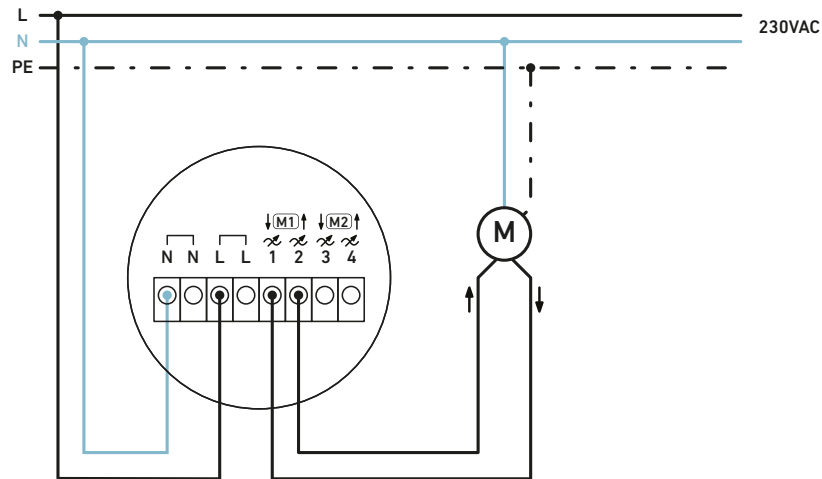

Two blinds

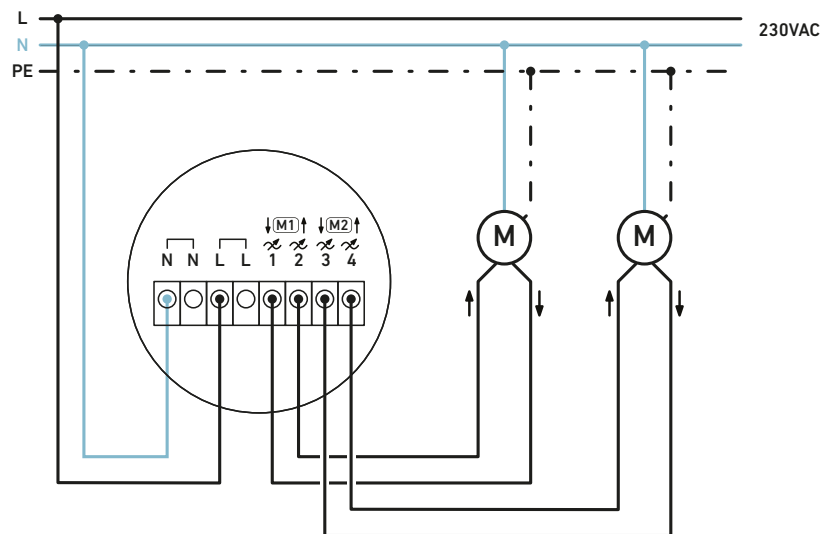

After completing and checking the electrical installation and correctly setting the DIP switches on the dingz Base, the power supply can be turned on. After setting the limit switches of the electric blinds correctly, it is recommended to configure the blinds in the web interface:

1. Select the appropriate blind type from the motor menu:

- **Slats:** Slat blinds (with open slats when raised)
- **Solar blinds:** Blinds without slats (also suitable for gates or windows)

2. Start the initialization. The blinds go up - down - up and automatically determine the travel time. This is displayed in the web interface and can also be overwritten manually if required. In order to manually record the travel times, the automatic calibration of the corresponding blinds must first be deactivated.

3. Setting the slat tilt. This is the time it takes for the slats to move from the fully closed to the fully open position (typically 1.2 s to 1.8 s). Check the exact setting by standing in a specific position with the slats slightly open using the "Remote" function in the web interface, both from above and from below. If the slat time has been set exactly, the angle of opening of the slats is the same whether they were opened downwards or upwards.

Combining lamps and blinds

The input, thermostat, dimmer and blinds can be combined as desired. However, it is recommended to connect only one motor to outputs 3&4 and to use outputs 1 and 2 for lamps or other loads.

2 lamps and a blind. In this combination, the motor is always connected to outputs 3 and 4.

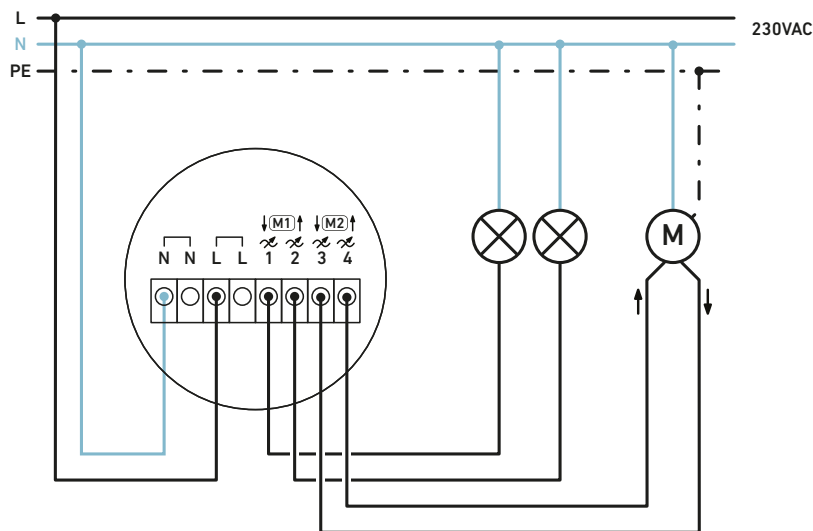

IF A MOTOR IS COMBINED WITH LAMPS, THE MOTOR MUST NOT BE CONNECTED TO 1&2.

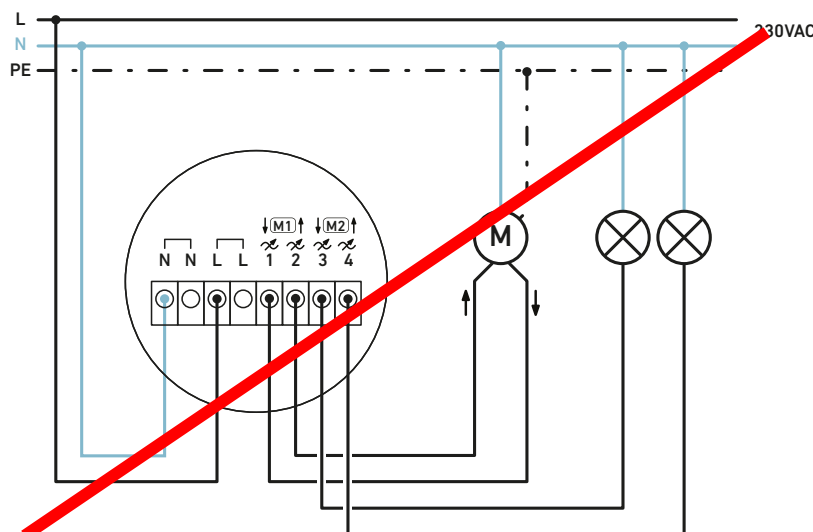

Connection of an electric heating valve

One or more electromechanical valves for floor heating can be connected directly to an output of the dingz.

Activate the thermostat function. If the thermostat function is activated in the web interface, dingz controls the heating valve according to the measured room temperature. The setpoint temperature can be adjusted using the dingz buttons, provided that a button has been configured as a thermostat button.

The set temperature can also be conveniently adjusted via the dingz app. Setting a thermostat button is optional in this case.

Configuration:

- **Thermostat -> activate = on** (makes the thermostat function available)
- **Thermostat -> output = 4** (when the valve is connected to port 4)
- **Thermostat -> valve reversal** (if the valve used is open at rest and not closed)
- **Thermostat -> Stand-by = off** (when on, the heater is temporarily out of service. Frost protection, minimum temperature control)

In option: push button -> Action = Thermostat (in order to be able to adjust the set temperature directly on the dingz with the buttons)



dingz

dingz by iolo AG - Pra Pury 7d - 3280 Murten

hello@iolo.ch - 026 674 60 00